

Series SPS

General Purpose Pressure Switch

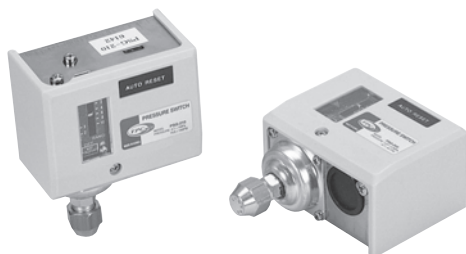

- APPLICATION FOR HYDRAULIC, PNEUMATIC PARTS, SEMI-CONDUCTOR, CNC MECHINE, OXYGEN PRODUCER, COMPRESSOR, CHEMICAL PLANT AND POWER PLANT ETC. CONTROL PRESSURE AUTOMATIVELY.
- COMPACT DESIGN
- LIGHT WEIGHT



How to Order

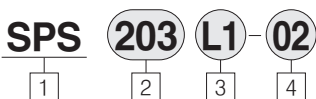

1 General Purpose Pressure Switch

2 Operating Pressure Range

- 203 : -0.05 ~ 0.3MPa(-0.5 ~ 3.1kgf)
- 206 : -0.05 ~ 0.6MPa(-0.5 ~ 6.1kgf)
- 210 : 0.01 ~ 1MPa(1 ~ 10.2kgf)
- 220 : 0.05 ~ 2MPa(5 ~ 20.4kgf)
- 230 : 0.05 ~ 3MPa(5 ~ 30.6kgf)

3 Lamp

- L1 : Lamp/AC110V
- L2 : Lamp/AC220V
- L5 : Lamp/DC24V

Canton : This product(for DC24V) includes a resistance for LED current restriction. If this product is applied PLC, there would be a current leakage trouble. Be careful.

4 Port Size

Blank : 7/16"~20(1/4" SAE Flare Type 45°)

01 : PT 1/4"

02 : PT 3/8"

03 : Ø2, 4×100 Capillary Tube, 1/4" Flare Nut

Specification

Item	Series	SPS-203	SPS-206	SPS-210	SPS-220	SPS-230
Fluid		Non Corrosive Water, Air, Liquids, Inert Gases, Steam				
Operating Pressure(kgf/cm ²)		0 ~ 3	0 ~ 6	1 ~ 10	5 ~ 20	5 ~ 30
Ambient and Fluid Temperature(°C)		-10 ~ 120°C (14~248°F)				
Range of On-Off control(kgf/cm ²)		0.35 ~ 2(4.98~28.44psi)	0.6~4(8.53~56.88psi)	1~3(14.22~42.66psi)	3~5(42.66~71.1psi)	3~10(42.66~142.2psi)
Proof Pressure kgf/cm ² (psi)		11(156psi)	16.5(235psi)		40(569psi)	
Weight(kg)		0.42(0.93 lbs)				
Connection		1ab(When pressure increasing, ON or OFF)				
Operate Frequency		1 Time / 1 sec				
Durability		100,000 Times or more				
Power Supply		AC110V 10A / AC220V 5A				
Using Voltage		DC24V, AC110V, AC220V				
Max. Supply Voltage		2 ~ 5A				
Shock Resistance		30G				

Using Fluid

Material of parts which meets Fluid must be considered.

Fluid	Material	
	Bellows	Parts which meets fluid
Non corrosive water, air, liquids, inert gases	Phosphorus/bronze	C3604B
※ Fluid which can't be corroded under 302°F		

※ Use under 176°F at atmosphere.

Connection Structure

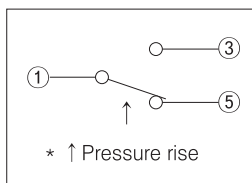

1 : Common Terminal

3 : Close on, Pressure Decrease

5 : Close on, Pressure Increase

Series SPS

Construction

- SPSA
- SPSB
- Auto Switch
- SPS**

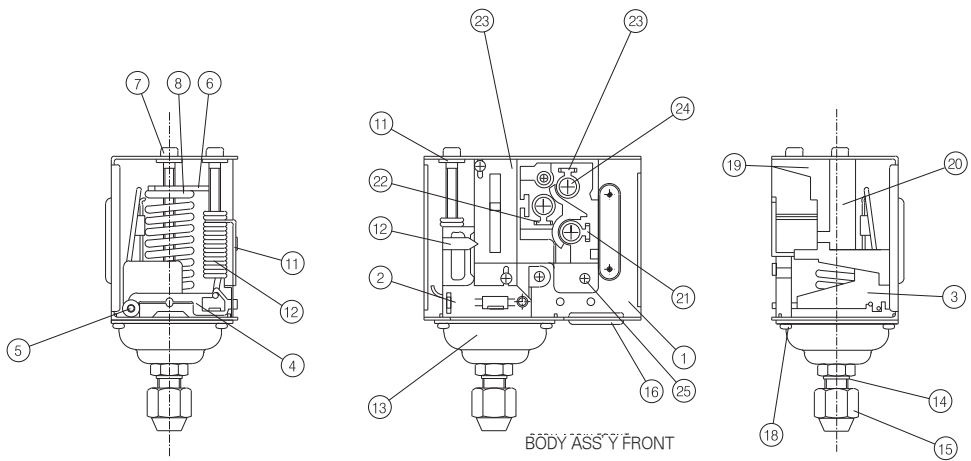

Parts List

No.	Name	Material	Note
①	Body	SPCC	
②	Flat	SPCC	
③	Lever	SPCC	
④	Lever Guide	SPCC	
⑤	Lever Pin	SUS	
⑥	Spring Stopper	SPCC	
⑦	Aed	SWCH	
⑧	Coil Spring	SWP	
⑨	Diff Spring Nut	SPCC	
⑩	Diff Spring	SWP	
⑪	Eding	SK	∅ 4
⑫	Point	P.P	
⑬	Rod Boot	BSP	

No.	Name	Material	Note
⑭	Supporting Bolt	BSME	
⑮	Supporting Nut	BSME	
⑯	Packing	CR	
⑰	Scale Flat	AL	
⑱	Screw	SWCH	3×5
⑲	Switch Box	PHENOL	
⑳	Switch Cover	N6	
㉑	Terminal	BSP	
㉒	Lower of Terminal	BSP	
㉓	Upper of Terminal	BSP	
㉔	Supporting pin of terminal	BS	BS 4×5
㉕	Supporting Bolt	SWCH	3×10

Dimensions (mm)

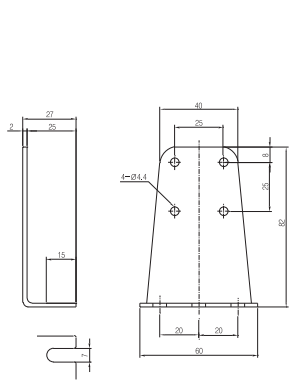

Mounting Accessory

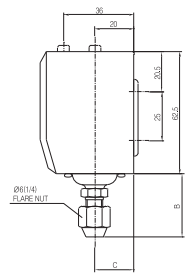
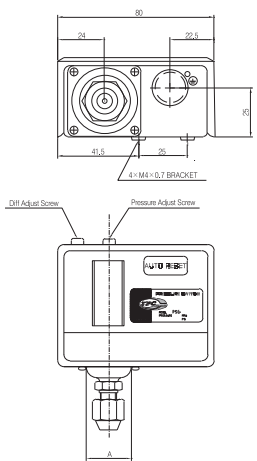

Model	A	B	C
SPS203	38.5	38.9	22.4
SPS206	34.4	36	22.4
SPS210			
SPS220	22	32.7	18.5
SPS230			

Model	B
SPS-203-01	48.9
SPS-206-01	46
SPS-210-01	46
SPS-220-01	42.7
SPS-230-01	42.7
SPS-203-02	39.9
SPS-206-02	37
SPS-210-02	37
SPS-220-02	33.7
SPS-230-02	33.7